

Part Number: DC10EWA HIGH EFFICIENCY RED

Features

- SUITABLE FOR LEVEL INDICATORS.
- LOW CURRENT OPERATION.
- EXCELLENT ON/OFF CONTRAST.
- WIDE VIEWING ANGLE.
- END STACKABLE.
- MECHANICALLY RUGGED.
- BI-COLOR VERSION AVAILABLE.
- STANDARD : GRAY FACE, WHITE SEGMENT.
- RoHS COMPLIANT.

Description

The High Efficiency Red source color devices are made With Gallium Arsenide Phosphide on Gallium Phosphide Orange Light Emitting Diode.

Package Dimensions & Internal Circuit Diagram

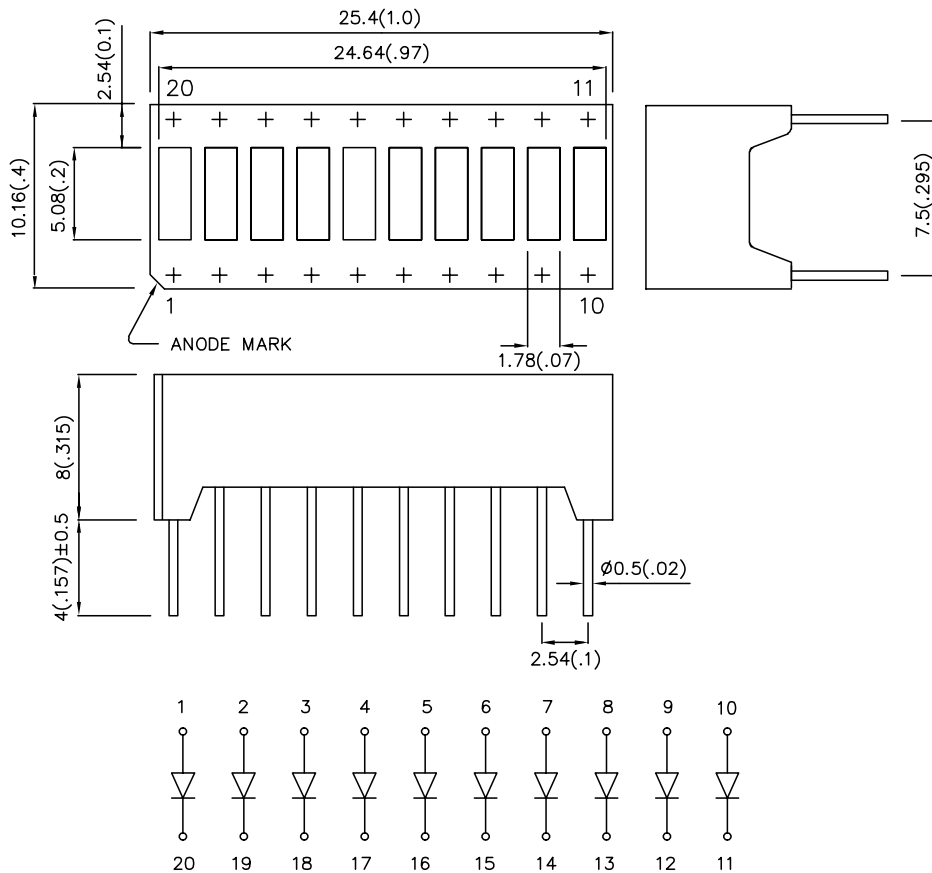

Notes:

1. All dimensions are in millimeters (inches), Tolerance is ±0.25(0.01")unless otherwise noted.
2. Specifications are subject to change without notice.

Selection Guide

Part No.	Dice	Lens Type	Iv (ucd) [1] @ 10mA		Description
			Min.	Typ.	
DC10EWA	HIGH EFFICIENCY RED (GaAsP/GaP)	WHITE DIFFUSED	1900	9000	10 Segments Bargraph-Display

Note:

1. Luminous Intensity/ Luminous Flux: +/-15%.

Electrical / Optical Characteristics at TA=25°C

Symbol	Parameter	Device	Typ.	Max.	Units	Test Conditions
λ_{peak}	Peak Wavelength	High Efficiency Red	627		nm	IF=20mA
λ_D [1]	Dominant Wavelength	High Efficiency Red	625		nm	IF=20mA
$\Delta\lambda_{1/2}$	Spectral Line Half-width	High Efficiency Red	45		nm	IF=20mA
C	Capacitance	High Efficiency Red	15		pF	VF=0V;f=1MHz
VF [2]	Forward Voltage	High Efficiency Red	2.0	2.5	V	IF=20mA
IR	Reverse Current	High Efficiency Red		10	uA	VR = 5V

Notes:

1. Wavelength: +/-1nm.
2. Forward Voltage: +/-0.1V.

Absolute Maximum Ratings at TA=25°C

Parameter	High Efficiency Red	Units
Power dissipation	105	mW
DC Forward Current	30	mA
Peak Forward Current [1]	160	mA
Reverse Voltage	5	V
Operating / storage Temperature	-40°C To +85°C	
Lead Solder Temperature [2]	260°C For 3 Seconds	

Notes:

1. 1/10 Duty Cycle, 0.1ms Pulse Width.
2. 2mm below package base.

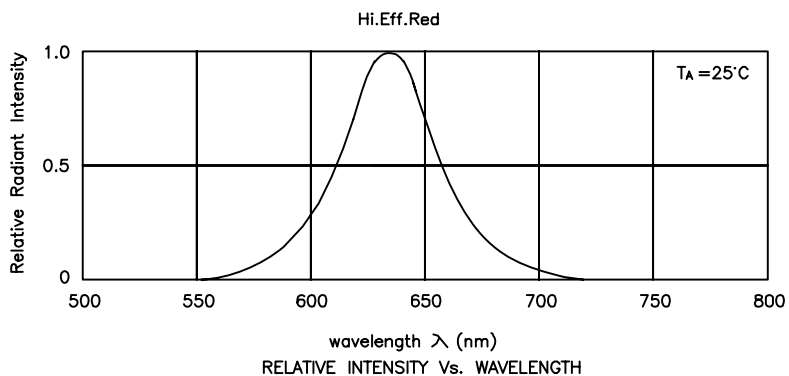

High Efficiency Red

DC10EWA

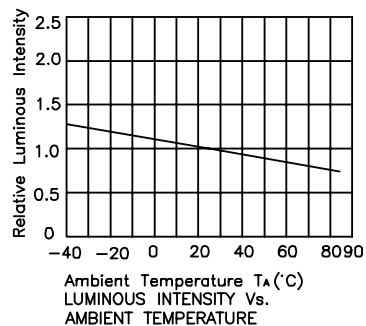
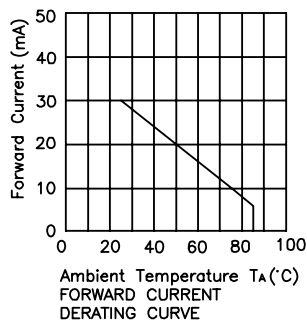
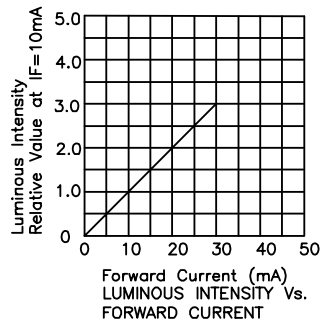
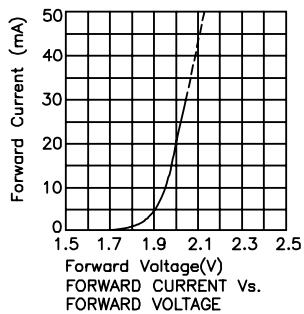

PACKING & LABEL SPECIFICATIONS

DC10EWA

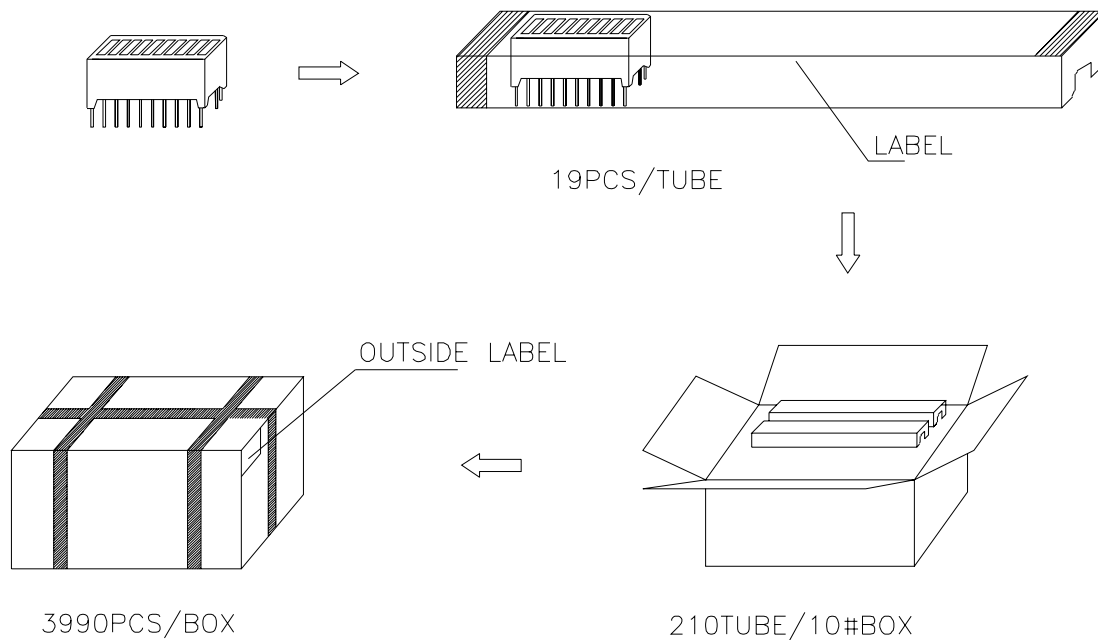

Inside LABEL Paste On The IC-tube

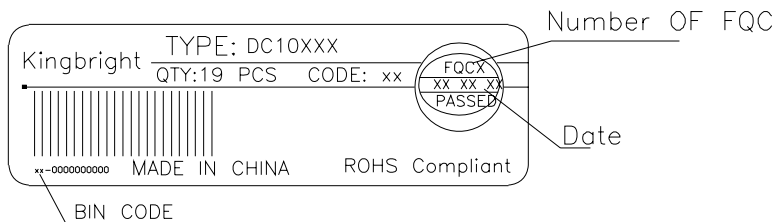

Outside LABEL Paste On The Box

