

Bias Resistor Transistor

NPN Silicon Surface Mount Transistor with Monolithic Bias Resistor Network

This new series of digital transistors is designed to replace a single device and its external resistor bias network. The BRT (Bias Resistor Transistor) contains a single transistor with a monolithic bias network consisting of two resistors; a series base resistor and a base-emitter resistor. The BRT eliminates these individual components by integrating them into a single device. The use of a BRT can reduce both system cost and board space. The device is housed in the SOT-23 package which is designed for low power surface mount applications.

- Simplifies Circuit Design
- Reduces Board Space and Component Count
- The SOT-23 package can be soldered using wave or reflow. The modified gull-winged leads absorb thermal stress during soldering eliminating the possibility of damage to the die.
- Available in 8 mm embossed tape and reel. Use the Device Number to order the 7 inch/3000 unit reel. Replace “T1” with “T3” in the Device Number to order the 13 inch/10,000 unit reel.

MAXIMUM RATINGS (T_A = 25°C unless otherwise noted)

Rating	Symbol	Value	Unit
Collector-Base Voltage	V _{CBO}	50	Vdc
Collector-Emitter Voltage	V _{CEO}	50	Vdc
Collector Current	I _C	100	mAdc
Total Power Dissipation @ T _A = 25°C (Note 1.) Derate above 25°C	P _D	246 1.5	mW °C/W

DEVICE MARKING AND RESISTOR VALUES

Device	Marking	R1(K)	R2(K)
LMUN2211LT1	A8A	10	10
LMUN2212LT1	A8B	22	22
LMUN2213LT1	A8C	47	47
LMUN2214LT1	A8D	10	47
LMUN2215LT1	A8E	10	∞
LMUN2216LT1	A8F	4.7	∞
LMUN2230LT1	A8G	1.0	1.0
LMUN2231LT1	A8H	2.2	2.2
LMUN2232LT1	A8J	4.7	4.7
LMUN2233LT1	A8K	4.7	47
LMUN2234LT1	A8L	22	47
LMUN2235LT1	A8M	2.2	47
LMUN2238LT1	A8R	2.2	∞
LMUN2241LT1	A8U	100	∞

1. Device mounted on a FR-4 glass epoxy printed circuit board using the minimum recommended footprint.

LMUN2211LT1 SERIES

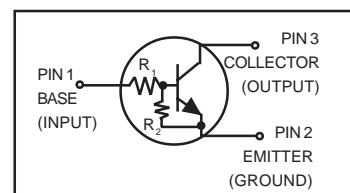
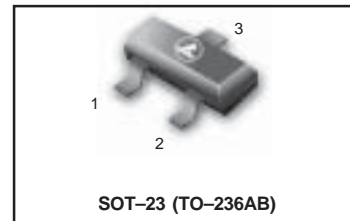

- Pb-Free Package May be Available. The G-Suffix Denotes a Pb-Free Lead Finish

ORDERING INFORMATION

Device	Package	Shipping
LMUN2211LT1G	SOT-23	3000/Tape & Reel
LMUN2212LT1G	SOT-23	3000/Tape & Reel
LMUN2213LT1G	SOT-23	3000/Tape & Reel
LMUN2214LT1G	SOT-23	3000/Tape & Reel
LMUN2215LT1G	SOT-23	3000/Tape & Reel
LMUN2216LT1G	SOT-23	3000/Tape & Reel
LMUN2230LT1G	SOT-23	3000/Tape & Reel
LMUN2231LT1G	SOT-23	3000/Tape & Reel
LMUN2232LT1G	SOT-23	3000/Tape & Reel
LMUN2233LT1G	SOT-23	3000/Tape & Reel
LMUN2234LT1G	SOT-23	3000/Tape & Reel
LMUN2235LT1G	SOT-23	3000/Tape & Reel
LMUN2238LT1G	SOT-23	3000/Tape & Reel
LMUN2241LT1G	SOT-23	3000/Tape & Reel

LMUN2211LT1 Series

THERMAL CHARACTERISTICS

Rating	Symbol	Value	Unit
Thermal Resistance – Junction-to-Ambient (Note 1.)	$R_{\theta JA}$	508	°C/W
Operating and Storage Temperature Range	T_J, T_{stg}	-55 to +150	°C
Maximum Temperature for Soldering Purposes, Time in Solder Bath	T_L	260 10	°C Sec

ELECTRICAL CHARACTERISTICS ($T_A = 25^\circ\text{C}$ unless otherwise noted)

Characteristic	Symbol	Min	Typ	Max	Unit
----------------	--------	-----	-----	-----	------

OFF CHARACTERISTICS

Collector-Base Cutoff Current ($V_{CB} = 50\text{ V}, I_E = 0$)	I_{CBO}	–	–	100	nAdc
Collector-Emitter Cutoff Current ($V_{CE} = 50\text{ V}, I_B = 0$)	I_{CEO}	–	–	500	nAdc
Emitter-Base Cutoff Current ($V_{EB} = 6.0\text{ V}, I_C = 0$)	I_{EBO}	–	–	0.5	mAdc
LMUN2211LT1		–	–	0.2	
LMUN2212LT1		–	–	0.1	
LMUN2213LT1		–	–	0.2	
LMUN2214LT1		–	–	0.9	
LMUN2215LT1		–	–	1.9	
LMUN2216LT1		–	–	4.3	
LMUN2230LT1		–	–	2.3	
LMUN2231LT1		–	–	1.5	
LMUN2232LT1		–	–	0.18	
LMUN2233LT1		–	–	0.13	
LMUN2234LT1		–	–	0.2	
LMUN2235LT1		–	–	4.0	
LMUN2238LT1		–	–	0.1	
LMUN2241LT1		–	–		
Collector-Base Breakdown Voltage ($I_C = 10\ \mu\text{A}, I_E = 0$)	$V_{(BR)CBO}$	50	–	–	Vdc
Collector-Emitter Breakdown Voltage (Note 2.), ($I_C = 2.0\text{ mA}, I_B = 0$)	$V_{(BR)CEO}$	50	–	–	Vdc

ON CHARACTERISTICS (Note 2.)

DC Current Gain ($V_{CE} = 10\text{ V}, I_C = 5.0\text{ mA}$)	h_{FE}	35	60	–	
LMUN2211LT1		60	100	–	
LMUN2212LT1		80	140	–	
LMUN2213LT1		80	140	–	
LMUN2214LT1		160	350	–	
LMUN2215LT1		160	350	–	
LMUN2216LT1		3.0	5.0	–	
LMUN2230LT1		8.0	15	–	
LMUN2231LT1		15	30	–	
LMUN2232LT1		80	200	–	
LMUN2233LT1		80	150	–	
LMUN2234LT1		80	140	–	
LMUN2235LT1		160	350	–	
LMUN2238LT1		160	350	–	
LMUN2241LT1					
Collector-Emitter Saturation Voltage ($I_C = 10\text{ mA}, I_B = 0.3\text{ mA}$) ($I_C = 10\text{ mA}, I_B = 5\text{ mA}$) LMUN2230LT1/LMUN2231LT1 ($I_C = 10\text{ mA}, I_B = 1\text{ mA}$) LMUN2215LT1/LMUN2216LT1 LMUN2232LT1/LMUN2233LT1/LMUN2234LT1/ LMUN2235LT1/LMUN2238LT1	$V_{CE(sat)}$	–	–	0.25	Vdc

2. Pulse Test: Pulse Width < 300 μs , Duty Cycle < 2.0%.

LMUN2211LT1 Series

ELECTRICAL CHARACTERISTICS ($T_A = 25^\circ\text{C}$ unless otherwise noted) (Continued)

Characteristic	Symbol	Min	Typ	Max	Unit
ON CHARACTERISTICS (Note 3.)					
Output Voltage (on) ($V_{CC} = 5.0\text{ V}$, $V_B = 2.5\text{ V}$, $R_L = 1.0\text{ k}\Omega$)	V_{OL}	–	–	0.2	Vdc
LMUN2211LT1		–	–	0.2	
LMUN2212LT1		–	–	0.2	
LMUN2214LT1		–	–	0.2	
LMUN2215LT1		–	–	0.2	
LMUN2216LT1		–	–	0.2	
LMUN2230LT1		–	–	0.2	
LMUN2231LT1		–	–	0.2	
LMUN2232LT1		–	–	0.2	
LMUN2233LT1		–	–	0.2	
LMUN2234LT1		–	–	0.2	
LMUN2235LT1		–	–	0.2	
LMUN2238LT1		–	–	0.2	
($V_{CC} = 5.0\text{ V}$, $V_B = 3.5\text{ V}$, $R_L = 1.0\text{ k}\Omega$)		–	–	0.2	
($V_{CC} = 5.0\text{ V}$, $V_B = 5.0\text{ V}$, $R_L = 1.0\text{ k}\Omega$)		–	–	0.2	
LMUN2213LT1		–	–	0.2	
LMUN2241LT1		–	–	0.2	
Output Voltage (off) ($V_{CC} = 5.0\text{ V}$, $V_B = 0.5\text{ V}$, $R_L = 1.0\text{ k}\Omega$) ($V_{CC} = 5.0\text{ V}$, $V_B = 0.050\text{ V}$, $R_L = 1.0\text{ k}\Omega$) ($V_{CC} = 5.0\text{ V}$, $V_B = 0.25\text{ V}$, $R_L = 1.0\text{ k}\Omega$)	V_{OH}	4.9	–	–	Vdc
LMUN2230LT1					
LMUN2215LT1					
LMUN2216LT1					
LMUN2233LT1					
LMUN2238LT1					
Input Resistor	R_1	7.0	10	13	$\text{k}\Omega$
LMUN2211LT1		15.4	22	28.6	
LMUN2212LT1		32.9	47	61.1	
LMUN2213LT1		7.0	10	13	
LMUN2214LT1		7.0	10	13	
LMUN2215LT1		3.3	4.7	6.1	
LMUN2216LT1		0.7	1.0	1.3	
LMUN2230LT1		1.5	2.2	2.9	
LMUN2231LT1		3.3	4.7	6.1	
LMUN2232LT1		3.3	4.7	6.1	
LMUN2233LT1		3.3	4.7	6.1	
LMUN2234LT1		15.4	22	28.6	
LMUN2235LT1		1.54	2.2	2.86	
LMUN2238LT1		1.54	2.2	2.88	
LMUN2241LT1		70	100	130	
Resistor Ratio	R_1/R_2	0.8	1.0	1.2	
LMUN2211LT1/LMUN2212LT1/LMUN2213LT1		0.17	0.21	0.25	
LMUN2214LT1		–	–	–	
LMUN2215LT1/LMUN2216LT1/LMUN2238LT1		–	–	–	
LMUN2241LT1		–	–	–	
LMUN2230LT1/LMUN2231LT1/LMUN2232LT1		0.8	1.0	1.2	
LMUN2233LT1		0.055	0.1	0.185	
LMUN2234LT1		0.38	0.47	0.56	
LMUN2235LT1		0.038	0.047	0.056	

3. Pulse Test: Pulse Width < 300 μs , Duty Cycle < 2.0%.

LMUN2211LT1 Series

TYPICAL ELECTRICAL CHARACTERISTICS
LMUN2211LT1

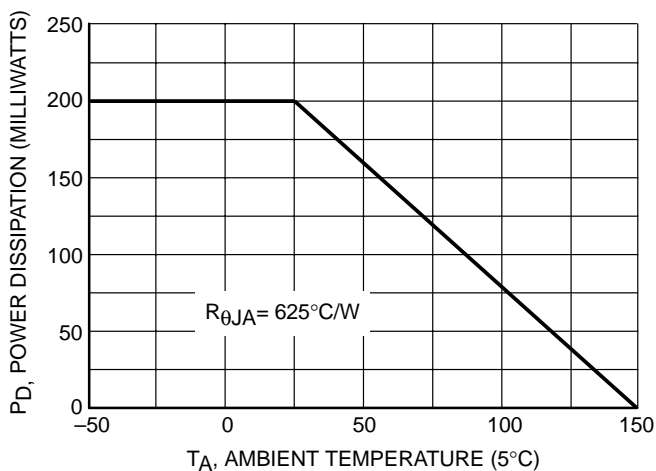

Figure 1. Derating Curve

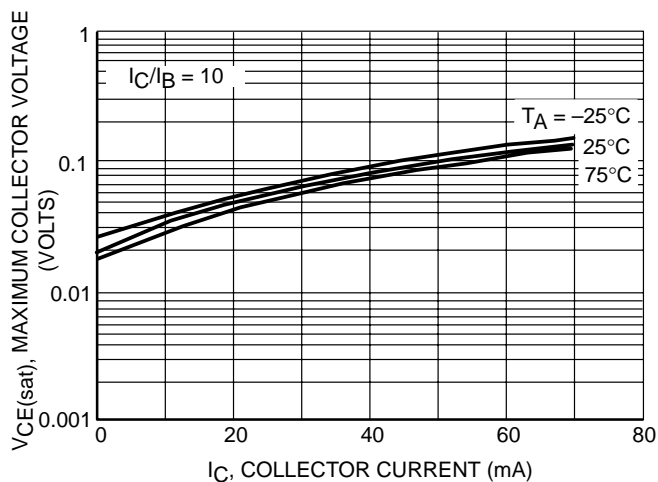

Figure 2. $V_{CE(sat)}$ vs. I_C

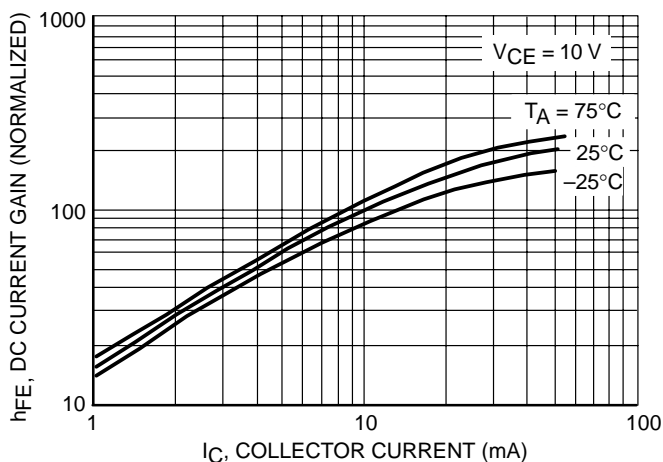

Figure 3. DC Current Gain

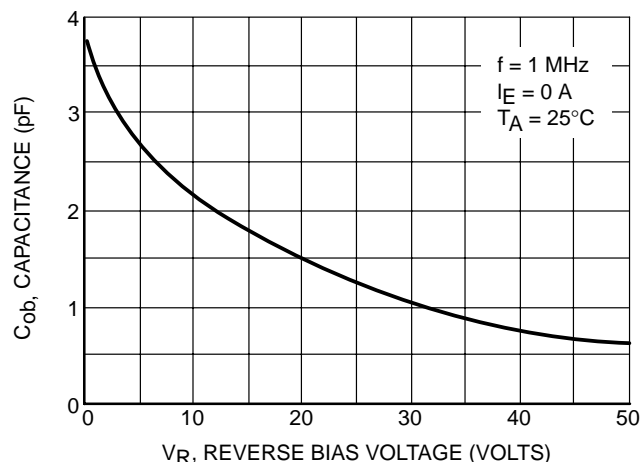

Figure 4. Output Capacitance

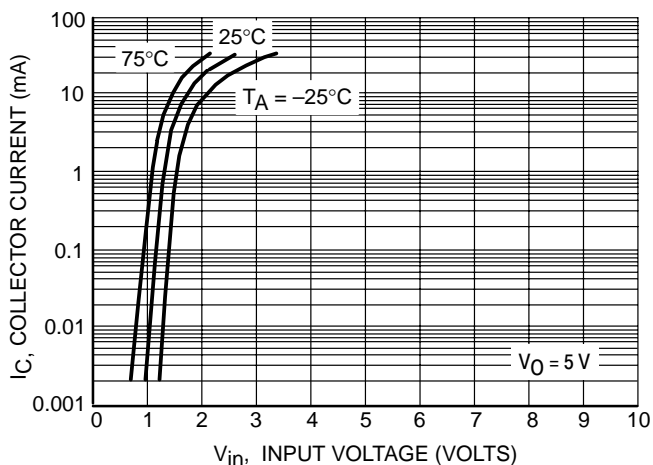

Figure 5. Output Current vs. Input Voltage

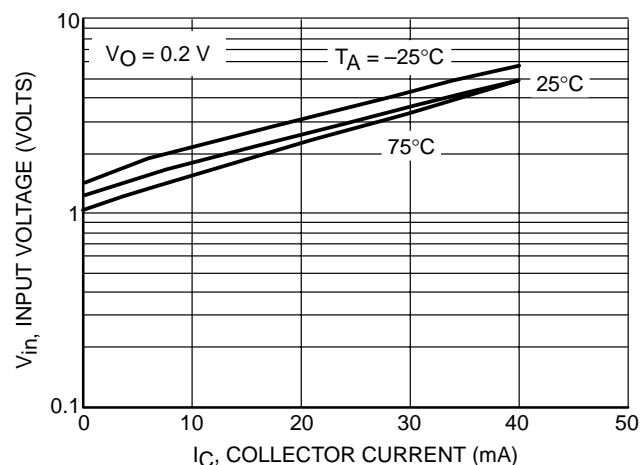

Figure 6. Input Voltage vs. Output Current

LMUN2211LT1 Series

TYPICAL ELECTRICAL CHARACTERISTICS
LMUN2212LT1

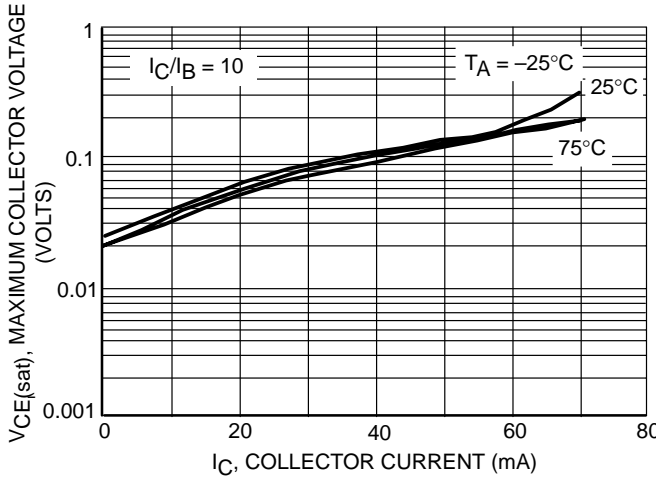

Figure 7. $V_{CE(sat)}$ vs. I_C

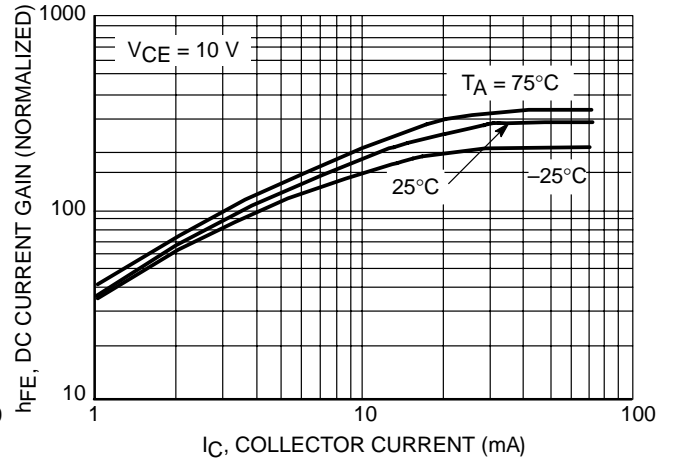

Figure 8. DC Current Gain

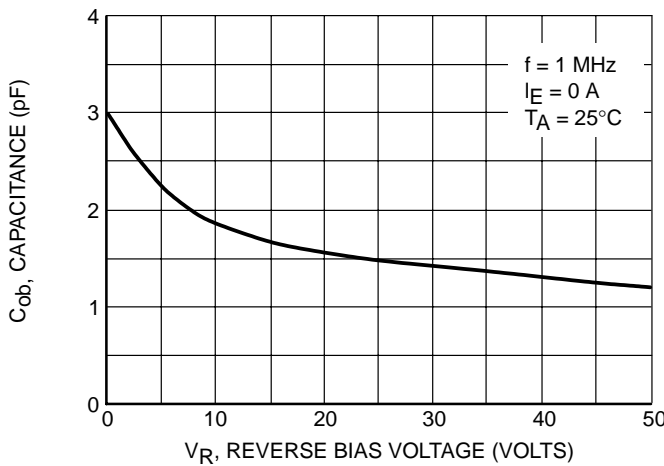

Figure 9. Output Capacitance

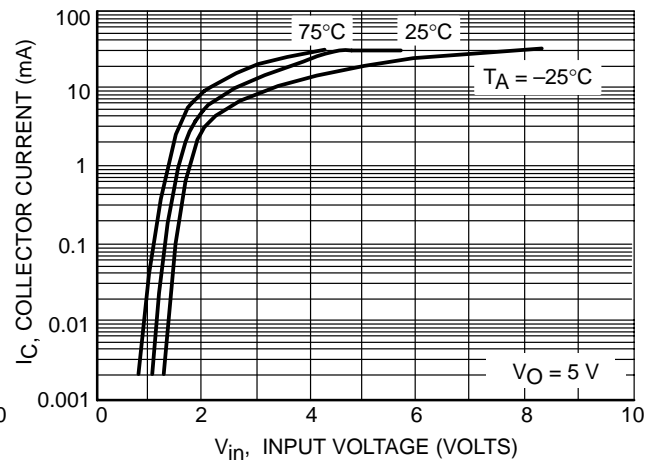

Figure 10. Output Current vs. Input Voltage

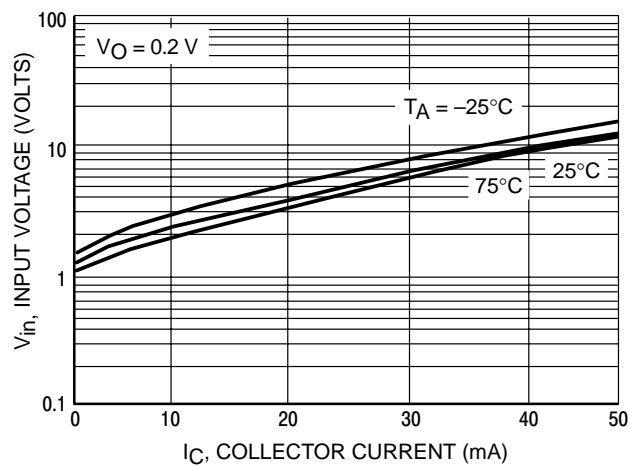

Figure 11. Input Voltage vs. Output Current

LMUN2211LT1 Series

TYPICAL ELECTRICAL CHARACTERISTICS
LMUN2213LT1

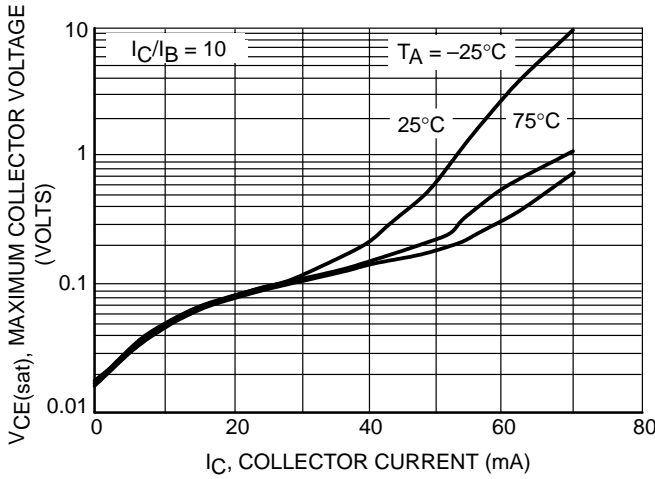

Figure 12. $V_{CE(sat)}$ vs. I_C

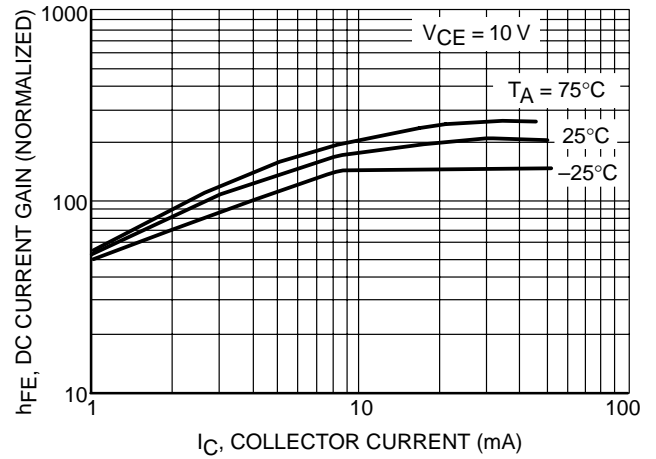

Figure 13. DC Current Gain

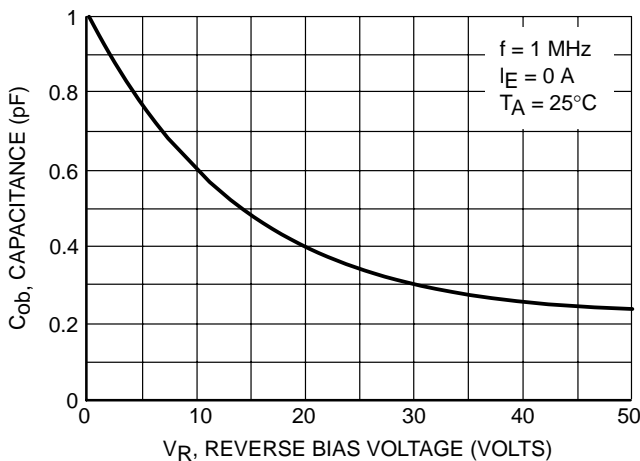

Figure 14. Output Capacitance

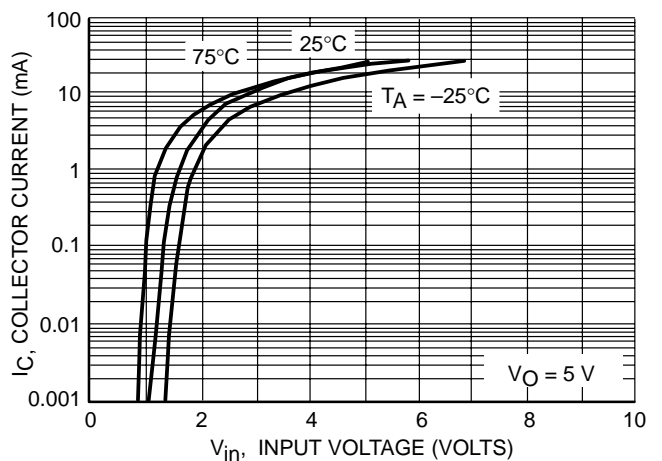

Figure 15. Output Current vs. Input Voltage

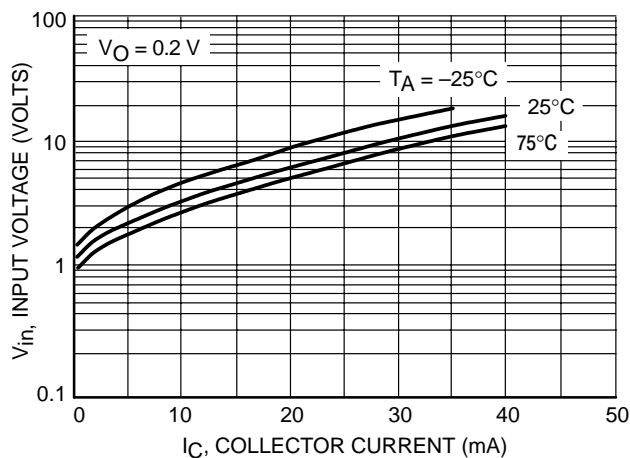

Figure 16. Input Voltage vs. Output Current

LMUN2211LT1 Series

TYPICAL ELECTRICAL CHARACTERISTICS
LMUN2214LT1

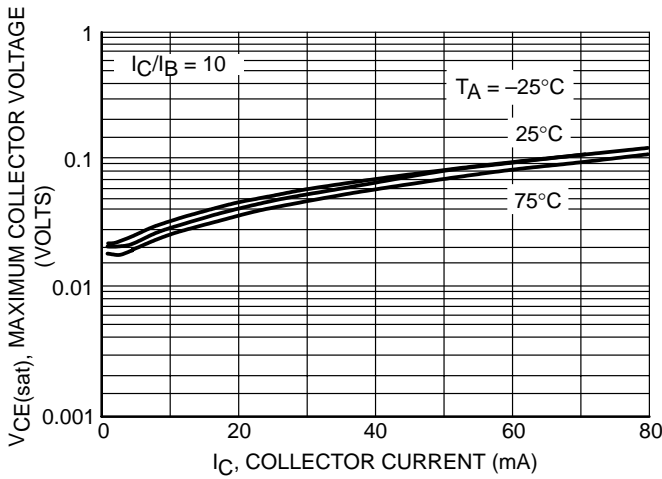

Figure 17. $V_{CE(sat)}$ vs. I_C

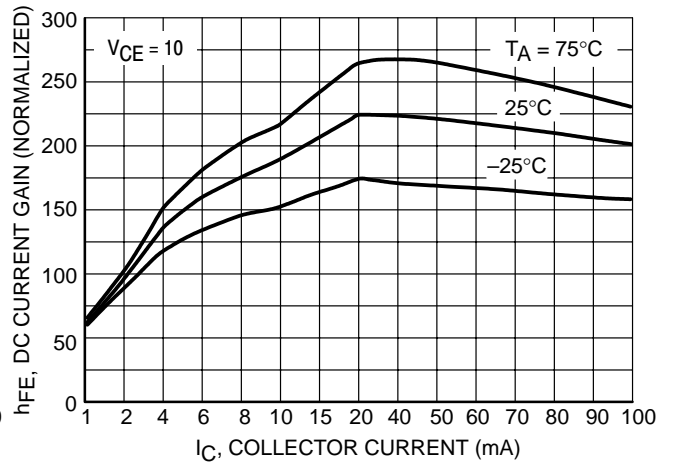

Figure 18. DC Current Gain

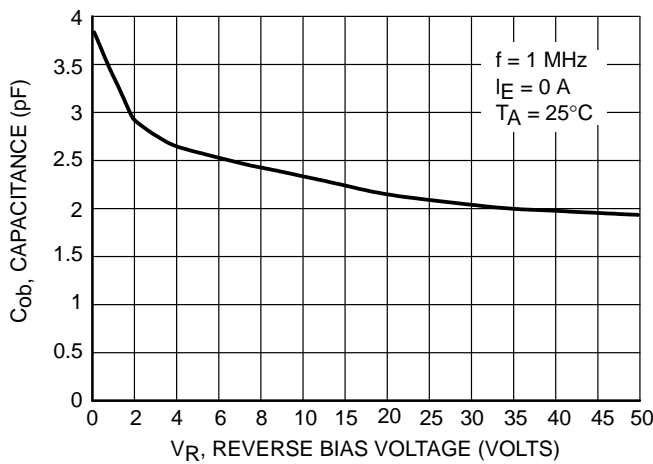

Figure 19. Output Capacitance

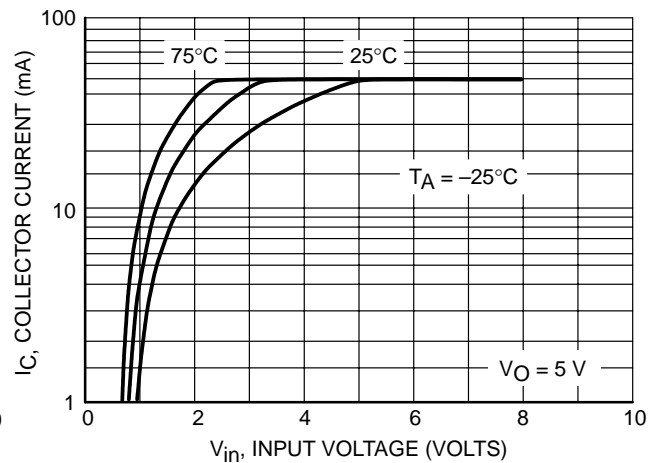

Figure 20. Output Current vs. Input Voltage

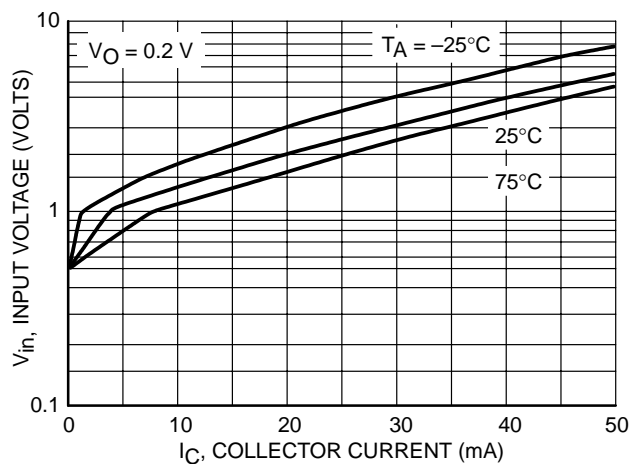

Figure 21. Input Voltage vs. Output Current

LMUN2211LT1 Series

TYPICAL ELECTRICAL CHARACTERISTICS
LMUN2232LT1

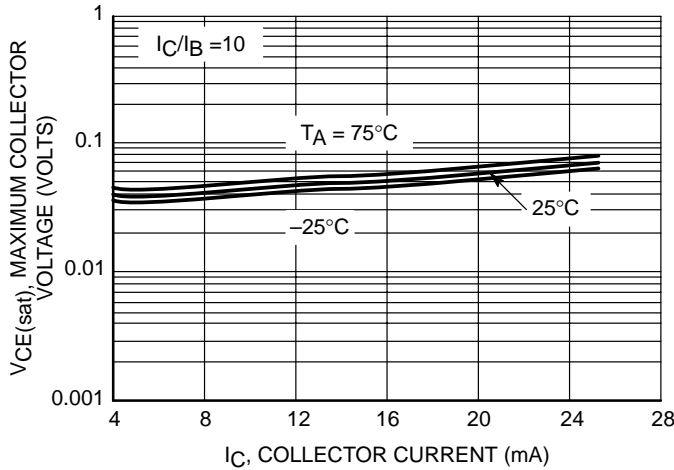

Figure 22. $V_{CE(sat)}$ vs. I_C

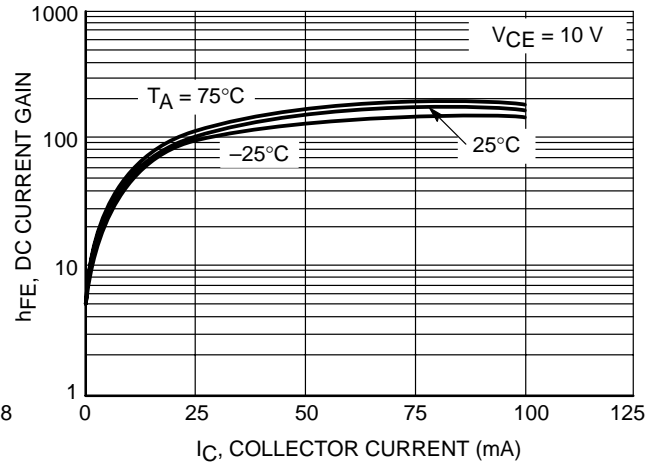

Figure 23. DC Current Gain

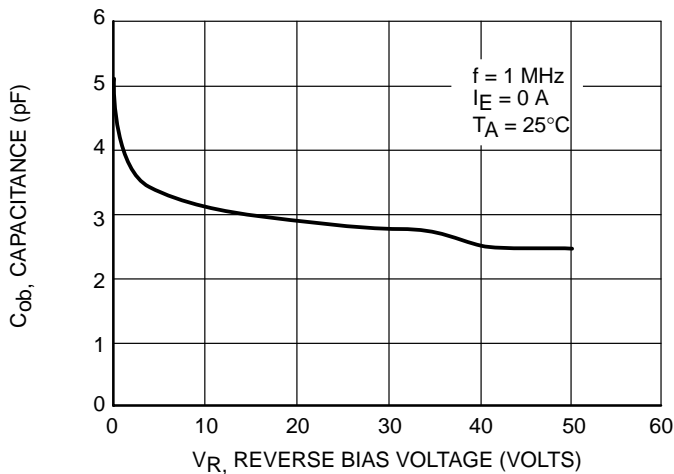

Figure 24. Output Capacitance

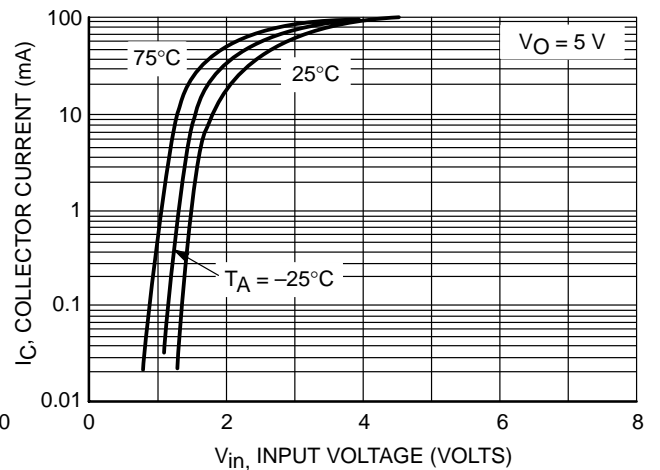

Figure 25. Output Current vs. Input Voltage

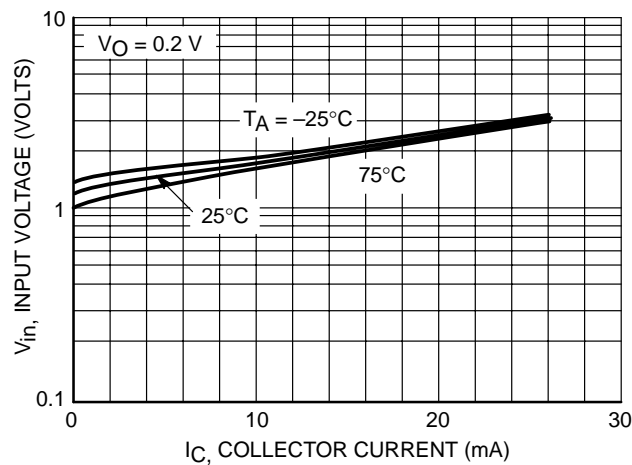

Figure 26. Output Voltage vs. Input Current

LMUN2211LT1 Series

TYPICAL ELECTRICAL CHARACTERISTICS
LMUN2233LT1

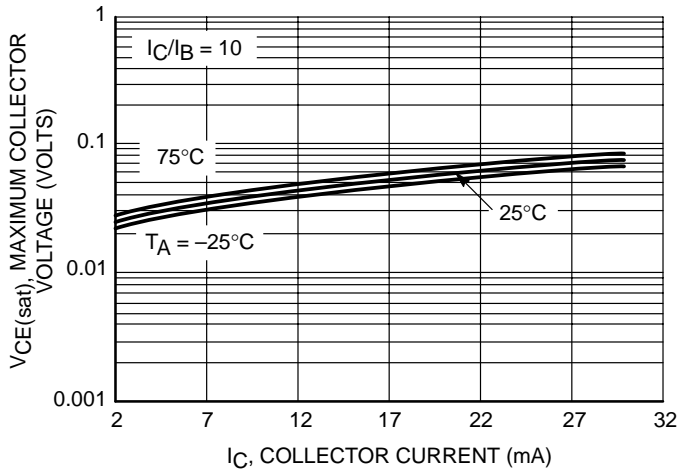

Figure 27. $V_{CE(sat)}$ vs. I_C

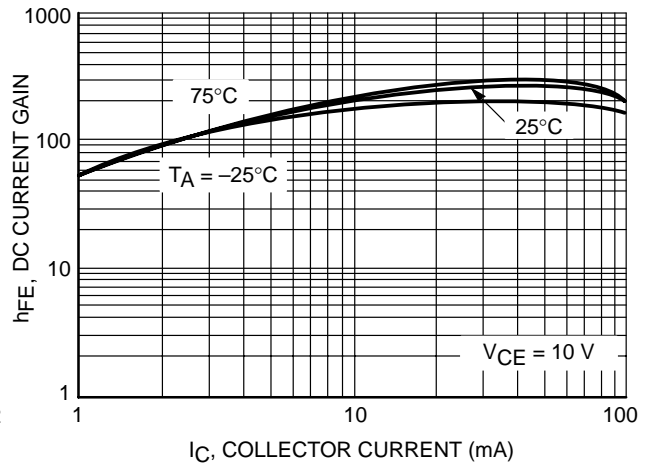

Figure 28. DC Current Gain

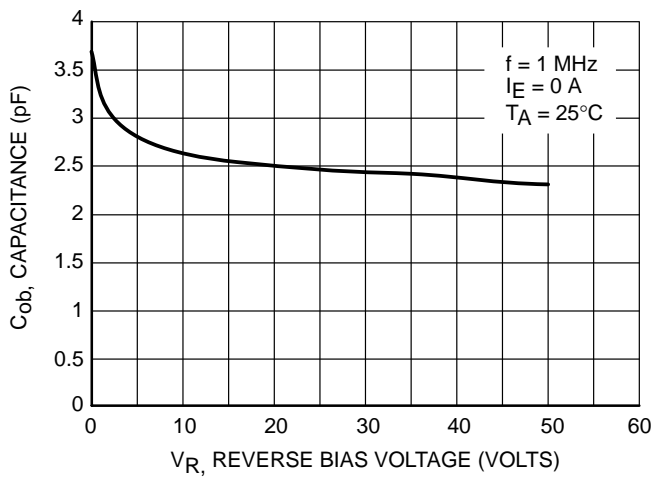

Figure 29. Output Capacitance

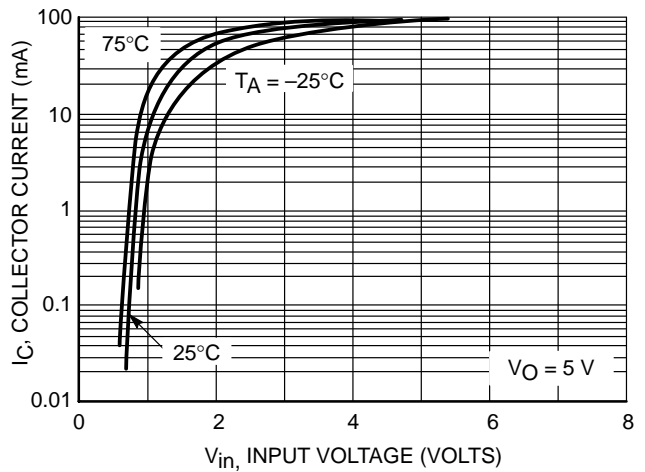

Figure 30. Output Current vs. Input Voltage

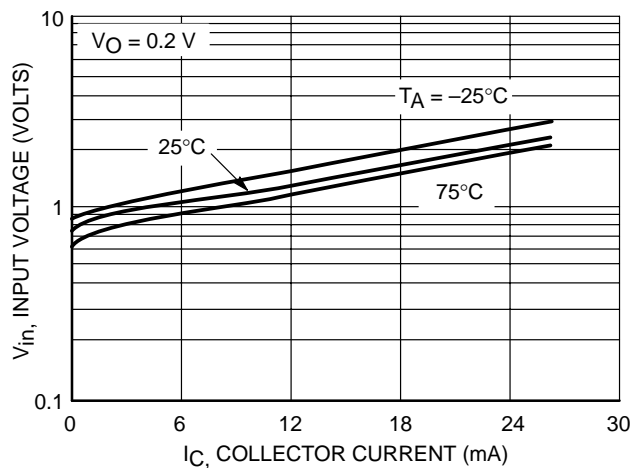

Figure 31. Input Voltage vs. Output Current

LMUN2211LT1 Series

TYPICAL APPLICATIONS FOR NPN BRTs

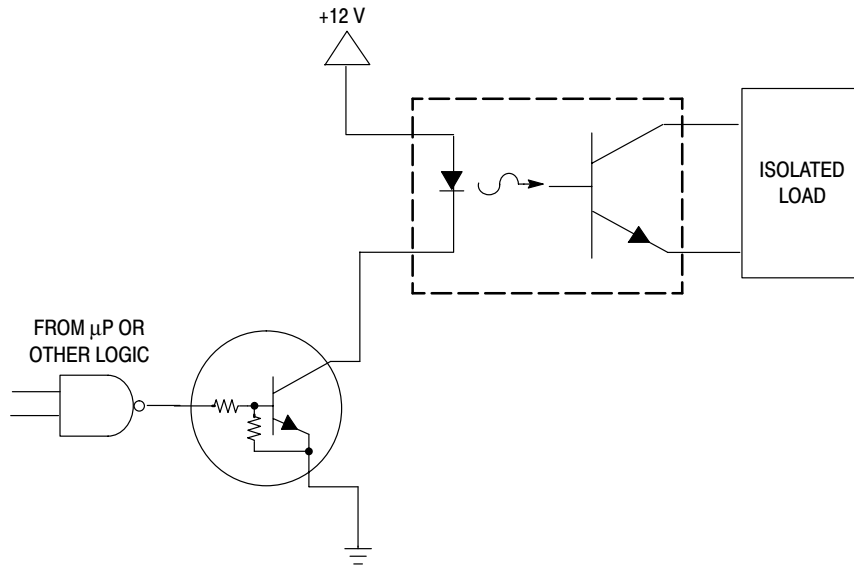

Figure 32. Level Shifter: Connects 12 or 24 Volt Circuits to Logic

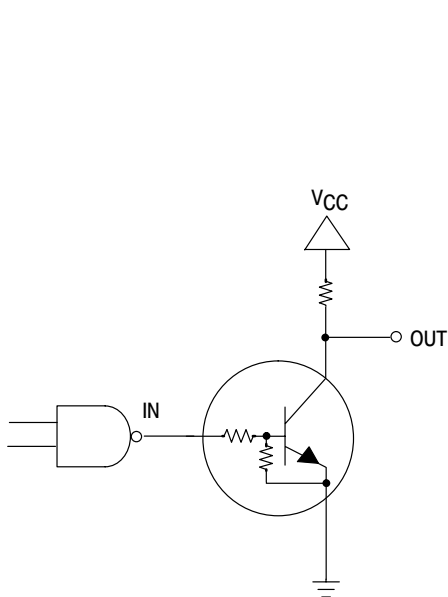

Figure 33. Open Collector Inverter: Inverts the Input Signal

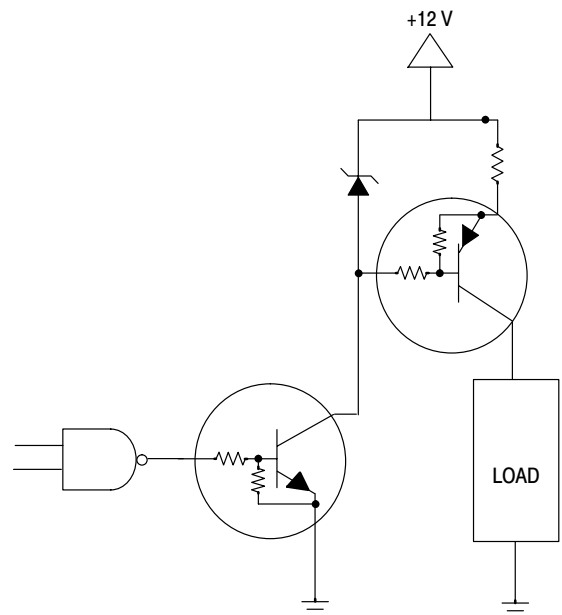
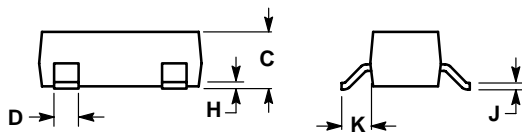
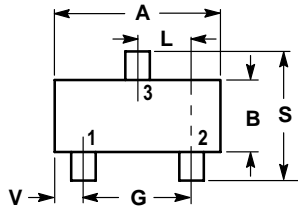

Figure 34. Inexpensive, Unregulated Current Source

LMUN2211LT1 Series

SOT-23



NOTES:

1. DIMENSIONING AND TOLERANCING PER ANSI Y14.5M, 1982.
2. CONTROLLING DIMENSION: INCH.

DIM	INCHES		MILLIMETERS	
	MIN	MAX	MIN	MAX
A	0.1102	0.1197	2.80	3.04
B	0.0472	0.0551	1.20	1.40
C	0.0350	0.0440	0.89	1.11
D	0.0150	0.0200	0.37	0.50
G	0.0701	0.0807	1.78	2.04
H	0.0005	0.0040	0.013	0.100
J	0.0034	0.0070	0.085	0.177
K	0.0140	0.0285	0.35	0.69
L	0.0350	0.0401	0.89	1.02
S	0.0830	0.1039	2.10	2.64
V	0.0177	0.0236	0.45	0.60

