

THE INFORMATION CONTAINED IN THIS DOCUMENT IS PROPRIETARY. ANY REPRODUCTION IN WHOLE OR IN PART IS PROHIBITED.

REV	BY	DATE
A	TB	080320

NOTES: UNLESS OTHERWISE SPECIFIED
 1. ALL CAPACITOR VALUES ARE IN MICROFARADS.
 2. ALL RESISTOR VALUES ARE IN OHMS.

PENGUIN ROBOT SCHEMATIC REV A

Spare Gate Table		
Last Used	Not Used	Spare Gates
B2		
C11		
D5		
J6	J4	
R23		
S3		
U10	U7	
X1		

PHOTO RESISTOR

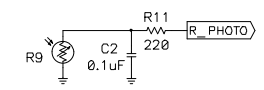

PING CONNECTOR

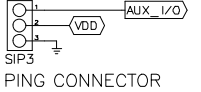
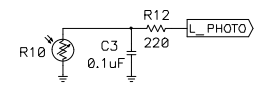
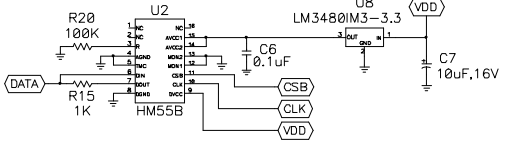

PHOTO RESISTOR



HM55B DIGITAL COMPASS



EEPROM

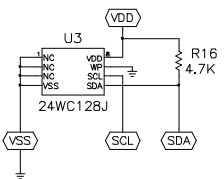

U5 SX48AC/SS

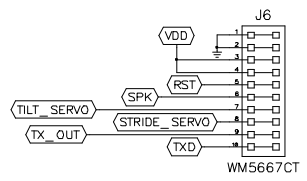
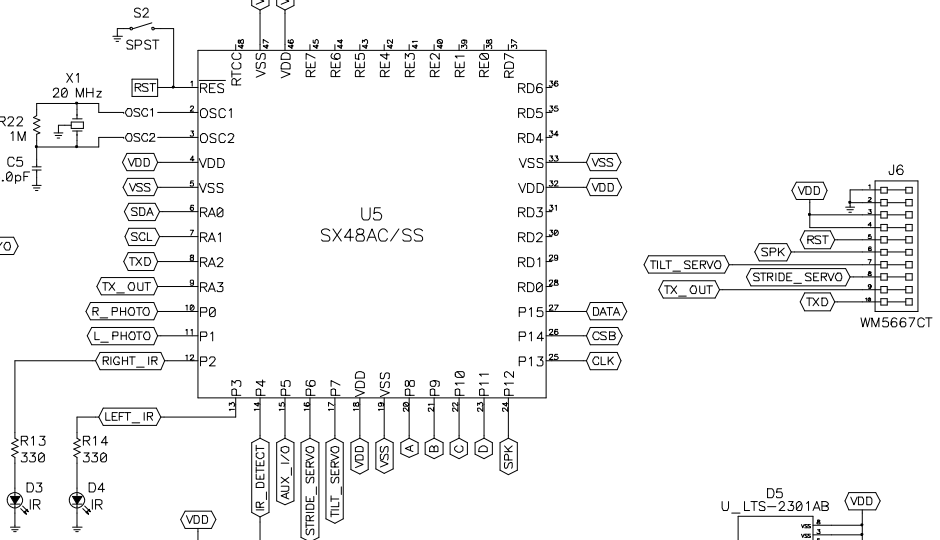

SEVEN SEGMENT LED DISPLAY

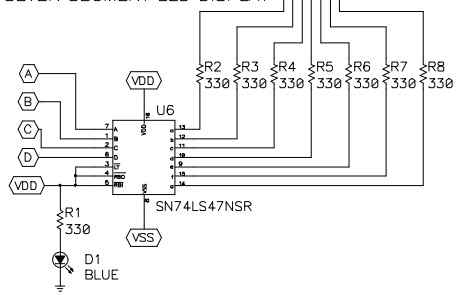

VOLTAGE REGULATOR

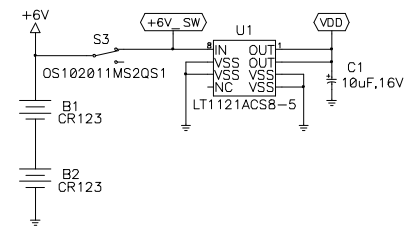

VDD = +5V
 THE LEFT SIDE COMPONENTS ARE POWERED BY THE RIGHT SIDE REGULATOR (U1)

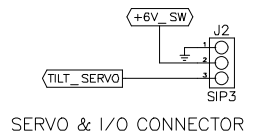

PIEZO SPEAKER

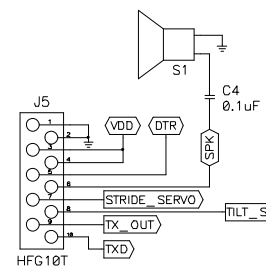

USB INTERFACE

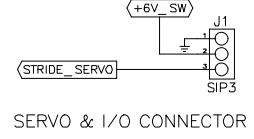
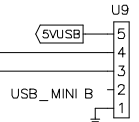
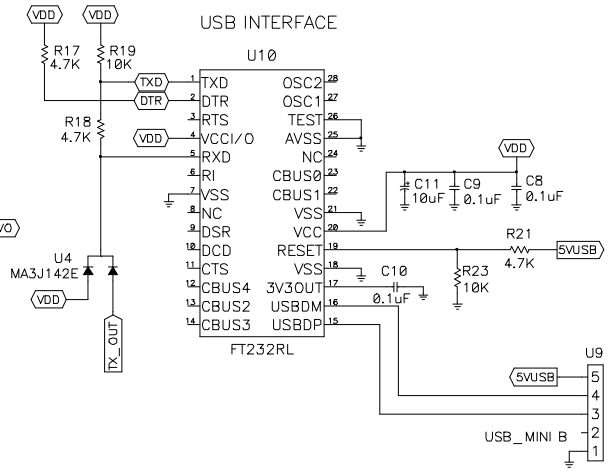

PARALLAX INC. MCKINLEY CA 95760 (916) 824-8333		
TITLE SCHEMATIC, PENGUIN ROBOT		
SIZE D	DWG NO 27313	REV A
SCALE NONE	SHEET 1 OF 1	